







01112/01116-LD/01126-LD/01126-29NB/01126-LLD7/01126-LLD/01126-LLD8/01126-29NBU	
Material	Housing:Made of ABS & PC
Housing Colour	Black
LED Colour	<input checked="" type="checkbox"/> Nature White <input type="checkbox"/> Warm White <input type="checkbox"/> Red <input type="checkbox"/> Green
LED	1pcs 1W
Colour Temperature	<input type="checkbox"/> Warm White: K <input checked="" type="checkbox"/> Nature White: 4500 K
Features	Surface mount
Working Voltage	DC8-30V
Wattage	1.3 W
Effective Lumen/Power compared to standard bulb	93Lumen/13W
water-proofing and dust-proofing	IP: 65
life TEST FOR LED LAMP(1000 hours)	Lumen Maintenance Percentage>90%
Operation Temperature	-20° ~ +45°C
Certificate	      

The light is for type "Z" attachments. The external flexible cable or cord of this luminaire cannot be replaced; if the cord is damaged, the luminaire shell be destroyed



LIFETIME FOR LUMEN MAINTENANCE

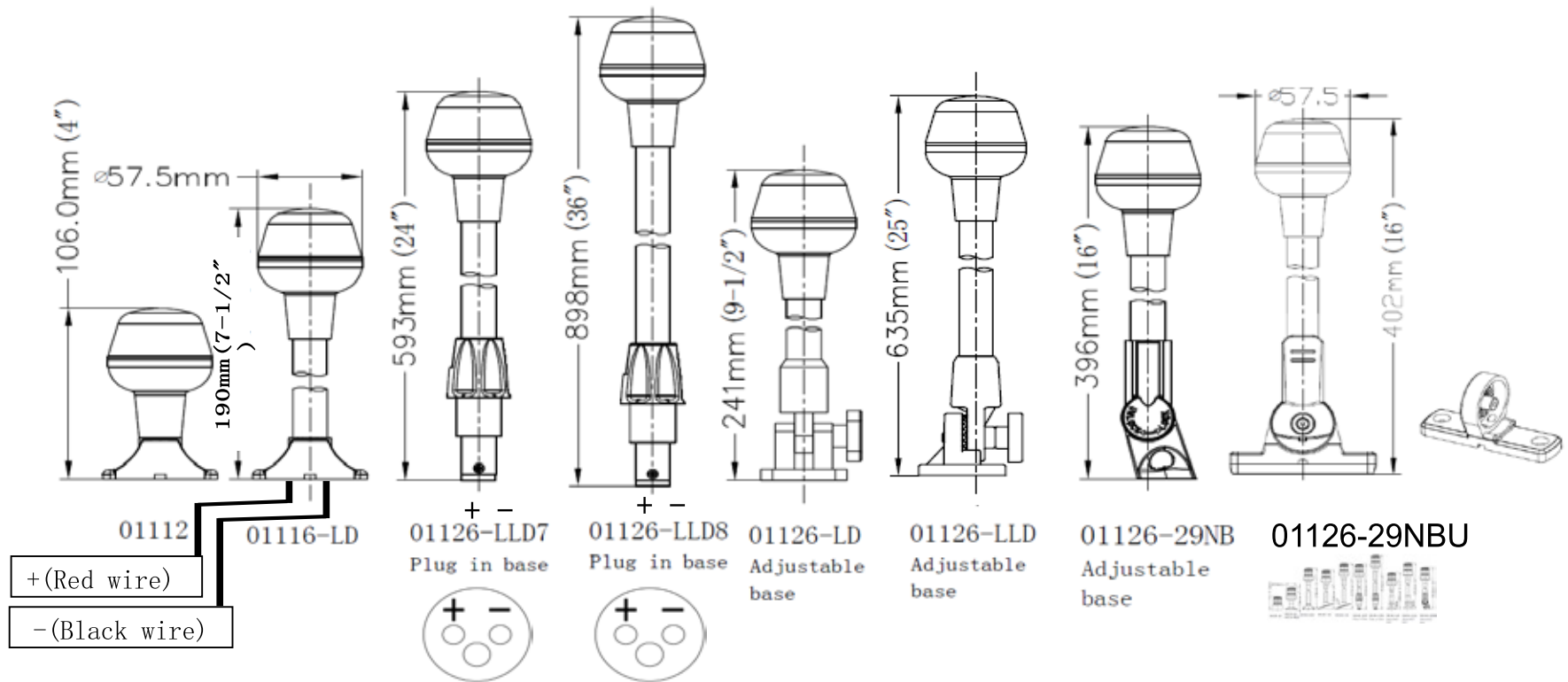
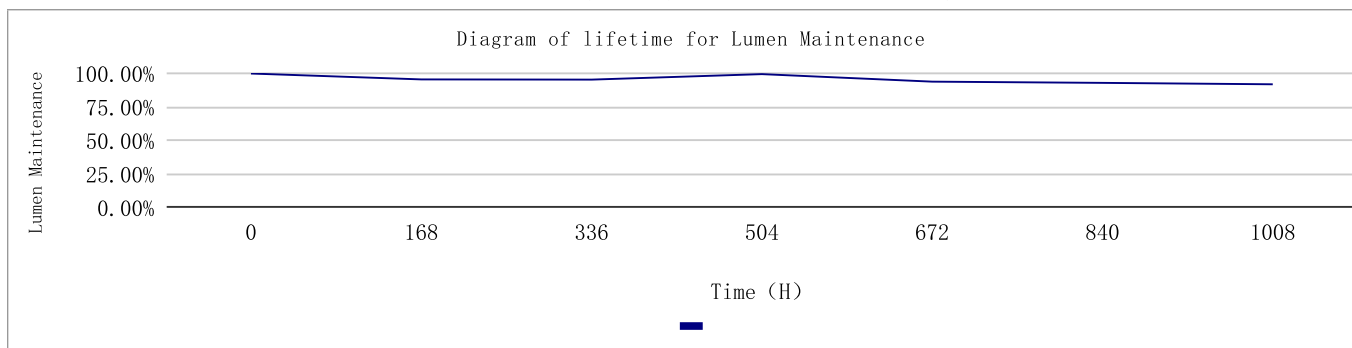

Testing Module: Lasting 1000 hrs, Temperature: Range 36-40°C, Humidity: 60%RH, Input Voltage: DC12V